



CAPT 凯普特传动
POWER TRANSMISSION

41
— SINCE 1986 —
CAPT POWER TRANSMISSION
1986-2026

CAPT 凯普特传动
POWER TRANSMISSION



官网/ Web : www.chssb.com
电话/ Tel : +86-311-68018026
邮件/ Email : chssb@chssb.com
地址/ Add : 中国河北省石家庄市藁城区新区国兴街1号



石家庄凯普特动力传输机械有限责任公司
SHIJIAZHUANG CAPT POWER TRANSMISSION CO., LTD.

企业简介



石家庄凯普特动力传输机械有限责任公司是一家集研发、生产及销售为一体的综合性、多品谱传动产品定制化智造企业，匠心专铸、卓越前行，始终坚持全球化发展战略，以高技术含量打造优秀品质，产品高精、稳定、耐用，助力传动高效能！

产品种类有链轮、皮带轮、同步带轮、锥套、胀套、齿轮、齿条、联轴器、驱动器、蜗轮蜗杆等160种类型，45000余种规格，覆盖国标、欧标、美标、日标等各国标准，年产各类机械传动零配件近千万件，同时拥有产品储备数量达50万件的中心成品仓库，可即时为全球用户提供各类机械传动件产品。

公司拥有自己专业的销售团队，精通英语及国际贸易的相关流程，可为国内外客户提供优质的服务。“CAPT”品牌产品畅销全球，成为北美、日本、欧洲及东南亚市场知名品牌，是中国目前机械传动产品综合生产厂之一。



企业文化

企业使命：

发展高新技术 制造高尖精品
服务全球传动

企业精神：

学习 修炼 进取 创新

经营理念：

关注客户需求引领进步
更优品质铸就CAPT传动品牌
真诚服务驱动CAPT传动远航

核心价值观：

厚德共生 至信共赢

企业作风：

终身成长 重人和
讲科学 求实效

行动原则：

快速反应 精细精工

人才战略：

崇德重能 知人善任

品质观：

精细 精准 精密 精工

见贤思齐



企业详细信息展示
官网：www.chssb.com



智能数字化管控
自主研发企业信息化系统，实现智能数字化综合管控



国内国际销售电话
国内：+86-311-68018026
国际：+86-311-68018088



快捷的库存系统
50万件的成品仓库储备，可快速大量现货供应



完整的产品系列
8大类产品，160种型号，45000种规格



高端定制化专家
可按客户需求，开展ODM、OEM、OBM定制化服务



凯普特传动

— SINCE 1986 —



精良的生产体系
数字化生产设备，全工序生产加工



严格的质量控制
齐全的质量检测设备，完善的过程质量控制



全方位商务模式
批量式定制生产、共享式库存直销、小批量零售等灵活的电子商务



可信赖的成本专家
有效控制产品和服务成本，以满足客户期望



整体的解决专家
提供动力传输研发、设计、生产、安装、售后等全生命周期解决方案



强大的技术支持
专业技术团队、全天候快速响应，强大技术支持



CAPT-DHT™ 双螺旋人字齿同步带轮

高精度传动, 更静、更稳、更节能、更长寿命



8M-14M
全系列产品

双螺旋人字齿同步带轮优势:

- 降噪声20%, 静音运行更友好
- 人字齿消轴向力, 传动超平稳
- 自对中免法兰, 省空间易安装
- 高承载耐剪切, 寿命大幅延长
- 低摩擦低损耗, 连续运转更节能
- 抗静电抗氧化, 安全可靠更耐用



锥孔TB产品安装优势:

- 一把扳手即可装, 安装简单又快捷
- 只换锥套不换件, 维修省心更省钱
- 过载打滑能保护, 设备运行更安全
- 锥面锁紧同心准, 高速运转更稳定
- 规格齐全适配广, 多种工况都适用
- 有效保护传动件, 延长整机使用寿命



CAPT-DHT™ 双螺旋人字齿同步带轮

双螺旋人字齿同步带轮可与BTL锥套配套使用、亦可与胀套联合适配, 装配灵活、连接刚性高、拆装便捷, 完美匹配工业传动系统多样化的安装与应用需求。

新产品



胀套在安装使用中的优势:

- 无需加热加压, 装拆一步到位
- 降低加工精度, 节省大量成本
- 无键无隙联结, 传动稳寿命长
- 轴向自由调位, 设备过载保护
- 耐温范围宽广, 适配各类环境
- 精密联结传动, 高效耐用省心

升级产品



选用CAPT-BTL钢质锥套优势:

- 标准通用适配广, 经济实用成本低
- 同心度高传动稳, 安全可靠不滚键
- 钢质材质强度高, 重载冲击更耐用
- 锥面锁紧精度高, 运行平稳效率高
- 拆装维护更方便, 更换简单不费件
- 高性价比寿命长, 绿色环保更节能

全系列45钢制TB锥套
1008-5050
6050-120100

CAPT-DHT™

双螺旋人字齿同步带轮

同步带轮与同步带相配型号和参数列表如下：

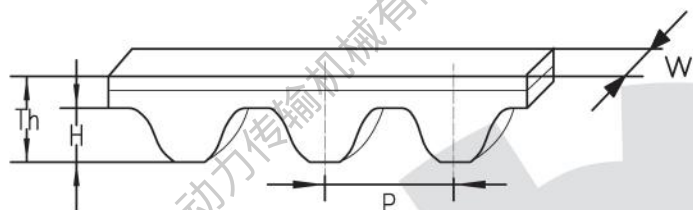

同步带截面

CAPT 凯普特传动 同步带轮参数				
带轮规格型号	Contitech 带轮型号	节距(P)mm	带轮齿宽度mm	齿数范围(Z)
8M16	Y	8	17	18~224
8M32	W	8	33	18~224
8M64	P	8	65	18~224
14M35	B	14	37	28~168
14M53	G	14	54.5	28~168
14M70	O	14	72	28~168
14M105	R	14	107	28~168

推荐配用双螺旋人字齿形皮带尺寸表



凯普特传动 带轮规格	人字齿形皮带参数(mm)			
	节距(P)	宽度(W)	厚度(Th)	齿高(H)
8M16	8	16	5.33	3.05
8M32	8	32	5.33	3.05
8M64	8	64	5.33	3.05
14M35	14	35	8.64	5.33
14M53	14	52.5	8.64	5.33
14M70	14	70	8.64	5.33
14M105	14	105	8.64	5.33

CAPT-BTL™

45钢制锥套



**高强度、高精度
高性价比、安全可靠
绿色环保、节能降耗**

BTL锥套安装说明

装配

- 1.对BTL锥套的孔及锥面进行清理，去油，同时清理皮带轮的锥孔，将BTL锥套从台侧装入皮带轮，并对齐螺栓孔。（半螺纹孔须与半卸孔对齐）；
- 2.在平头螺栓上滴少量润滑油，（适用于1008-3030锥套），或带帽螺钉（适用于3535以上到5050锥套），并拧入，但不拧紧；
- 3.对轴清洁、去油，将装了BTL锥套的皮带轮装到轴上，并固定到需要的位置；
- 4.有键的，要先将键配到轴上，这样键块和孔的键槽会有一个合适的间隙；
- 5.用一个内六角扳手，根据螺钉紧固扭矩表所列扭矩值逐渐的拧紧螺栓；
- 6.产品在载荷下运转一小段时间后（半小时到1小时），检查并确认螺钉拧紧扭矩处于恰当的值；
- 7.为减少灰尘进入，将所有空孔涂满润滑油。

拆卸

- 1.旋松并拆下所有的螺钉，并放在BTL锥套的拆卸螺孔里；
- 2.分别拧紧拆卸螺钉直到抱紧在锥套上的轮毂松动，BTL锥套内孔可以从轴上滑动；
- 3.从轴上取下BTL锥套。

BTL 锥套号	螺钉拧紧 扭矩(Nm)	螺钉	
		数量	规格
1008	5.6	2	1/4"
1108			BSW
1210	20	2	3/8"
1215			BSW
1310	20	2	3/8"
1315			BSW
1610	20	2	3/8"
1615			BSW
2012	31	2	7/16" BSW
2517	48	2	1/2" BSW
3020	90	2	5/8"
3030			BSW
3535	112	3	1/2" BSW
4040	170	3	5/8" BSW
4545	192	3	3/4" BSW
5050	271	3	7/8" BSW

CAPT-BTL锥套为商标注册产品，任何生产和销售得到授权和许可。

特殊说明

BTL锥套材质为优质45结构钢，我们也可以根据客户需要提供其他材质。

我们可根据客户需求做相应的表面处理（磷化，发蓝及镀锌，镀镍等）。

BTL锥套装配有高品质12.9级高强度螺钉。

CAPT-BTL™

45钢制锥套

BTL锥套许用扭矩数据 1008-5050

锥套规格	许用扭矩 N.M
1008	80-101
1108	116-180
1210	196-322
1215	196-322
1310	386-470
1610	255-393
1615	255-393
2012	414-568
2517	650-1090
2525	694-1090
3020	1675-1925
3030	1725-1925
3535	2760-4080
4040	4132-4980
4545	9750-12500
5050	20800-23000

CAPT-BTL钢制锥套许用扭矩N·M数值, 依锥套内孔直径自最小孔径至最大孔径递增, 许用扭矩N·M值逐步增大, 详细数值可查阅国家标准《GB/ T32220-2015 锥套 形式、尺寸和基本参数》相关许用扭矩N·M数值选用。

许用扭矩及传输功率数值基本公式:

T: 扭矩 N·M
P: 功率 KW
n: 转速 rpm

$$T = \frac{P \times 9550}{n}$$

功率计算:

$$\text{功率 (KW)} = \frac{\text{扭矩 (N·M)} \times \text{转速 (rpm)}}{9550}$$

扭矩计算:

$$\text{扭矩 (N·M)} = \frac{\text{功率 (KW)} \times 9550}{\text{转速 (rpm)}}$$

马力计算:

$$1 \text{ 马力 (PS)} = 0.7355 \text{ 功率 (KW)}$$



CAPT-BTL™

45钢制锥套

1008-120100
全系列钢制锥套

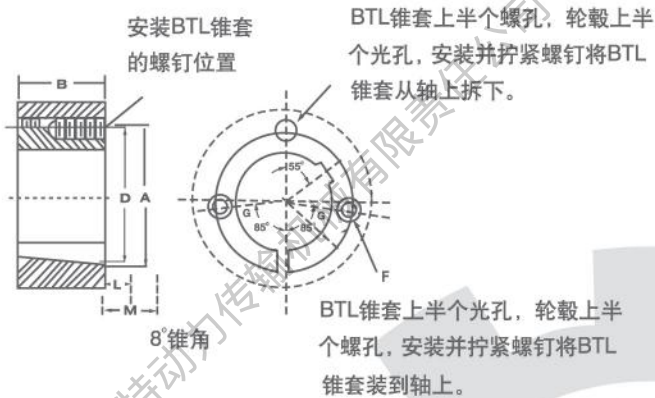

1008-3030 BTL锥套参数 (单位: 英寸)

锥套号	A	B	D	安装螺钉
1008	1.386	7/8	1 21/64	1/4x1/2
1108	1.511	7/8	1 29/64	1/4x1/2
1210	1 7/8	1	1 3/4	3/8x5/8
1215	1 7/8	1 1/2	1 3/4	3/8x5/8
1310	2	1	1 7/8	3/8x5/8
1610	2 1/4	1	2 1/8	3/8x5/8
1615	2 1/4	1 1/2	2 1/8	3/8x5/8
2012	2 3/4	1 1/4	2 5/8	7/16x7/8
2517	3 3/8	1 3/4	3 1/4	1/2x1
2525	3 3/8	2 1/2	3 1/4	1/2x1
3020	4 1/4	2	4	5/8x1 1/4
3030	4 1/4	3	4	5/8x1 1/4

需要两个螺钉

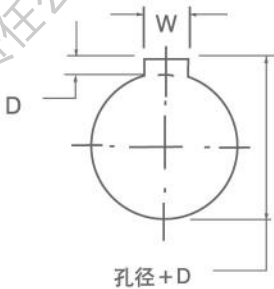

轴孔键槽形式和参数如图所示
测量键槽深度应通过中心

3535-5050 BTL锥套参数 (单位: 英寸)

锥套号	A	B	D	安装螺钉	G
3535	5	3 1/2	4.83	1/2x1 1/2	40°
3525	5	2 1/2	4.83		
4040	5 3/4	4	5.54	5/8x1 3/4	40°
4030	5 3/4	3	5.54		
4545	6 3/8	4 1/2	6.13	3/4x2	40°
4535	6 3/8	3 1/2	6.13		
5050	7	5	6.72	7/8x2 1/4	37°
5040	7	4	6.72		

需要三个螺钉



CAPT-BTL™

45钢制锥套—键槽尺寸

DIN 6885
JIS B 1301-1996
GB/T 1095-2003

公制尺寸键槽标准(A系列)

锥套号	孔径 d	键槽宽(W)x深(D)	锥套号	孔径 d	键槽宽(W)x深(D)	锥套号	孔径 d	键槽宽(W)x深(D)	锥套号	孔径 d	键槽宽(W)x深(D)	锥套号	孔径 d	键槽宽(W)x深(D)	锥套号	孔径 d	键槽宽(W)x深(D)
1008	10	3x1.40	1610	14	5x2.30	2517	20	6x2.80	3020	25	8x3.30	3535	35	10x3.30	4545	55	16x4.30
	11	4x1.80		16	6x2.80		22	8x3.30		28	10x3.30		38	12x3.30		60	16x4.40
	12	5x2.30		18	8x3.30		24	10x3.30		30	12x3.30		40	14x3.80		65	18x4.40
	14	6x2.80		19	10x3.30		25	12x3.30		32	14x3.80		42	16x4.30		70	20x4.90
	16	8x3.30		20	12x3.30		28	14x3.80		35	16x4.30		45	18x4.40		75	22x5.40
	18	8x2.00		22	12x2.20		30	16x4.30		38	18x4.40		48	20x4.90		80	25x5.40
	19	8x1.30		24	14x3.80		32	18x4.40		40	20x4.90		50	25x5.40		85	28x6.40
	20	8x1.30		25	14x3.80		35	18x4.40		42	20x4.90		55	25x5.40		90	25x5.40
	22	8x1.30		28	16x4.30		38	18x4.40		45	20x4.90		60	25x5.40		95	25x5.40
	24	8x2.00		30	18x4.40		40	18x4.40		48	20x4.90		65	25x5.40		100	25x5.40
	25	8x1.30		32	18x4.40		42	18x4.40		50	20x4.90		70	25x5.40		105	28x6.40
	1180	10		3x1.40	1615		14	5x2.30		2525	20		6x2.80	3030		25	8x3.30
11		4x1.80	16	6x2.80		22	8x3.30	28	10x3.30		38	14x3.80	65		20x4.90		
12		5x2.30	18	8x3.30		24	10x3.30	30	12x3.30		40	14x3.80	70		20x4.90		
14		6x2.80	19	10x3.30		25	12x3.30	32	14x3.80		42	16x4.30	75		22x5.40		
16		8x3.30	20	12x3.30		28	14x3.80	35	16x4.30		45	18x4.40	80		22x5.40		
18		8x3.30	22	12x2.20		30	16x4.30	38	18x4.40		48	20x4.90	85		25x5.40		
19		8x2.00	24	14x3.80		32	18x4.40	40	20x4.90		50	25x5.40	90		25x5.40		
20		8x2.00	25	14x3.80		35	18x4.40	42	20x4.90		55	25x5.40	95		25x5.40		
22		8x2.00	28	16x4.30		40	18x4.40	45	20x4.90		60	25x5.40	100		28x6.40		
24		8x3.30	30	18x4.40		42	18x4.40	48	20x4.90		65	25x5.40	105		28x6.40		
25		8x2.00	32	18x4.40		45	18x4.40	50	20x4.90		70	25x5.40	110		28x6.40		
1210		11	4x1.80	2012		18	6x2.80	2525	24		8x3.30	3030	28		10x3.30	4040	42
	12	5x2.30	19		8x3.30	25	10x3.30		30	12x3.30	45		16x4.30	70	22x5.40		
	14	6x2.80	20		10x3.30	28	12x3.30		32	14x3.80	48		18x4.40	75	22x5.40		
	16	8x3.30	22		12x3.30	30	14x3.80		35	16x4.30	50		20x4.90	80	25x5.40		
	18	8x3.30	24		14x3.80	32	16x4.30		38	18x4.40	55		20x4.90	85	25x5.40		
	19	8x3.30	25		14x3.80	35	18x4.40		40	20x4.90	60		25x5.40	90	25x5.40		
	20	8x3.30	28		16x4.30	40	18x4.40		42	20x4.90	65		25x5.40	95	25x5.40		
	22	8x3.30	30		18x4.40	42	18x4.40		45	20x4.90	70		25x5.40	100	28x6.40		
	24	10x3.30	32		18x4.40	45	18x4.40		48	20x4.90	75		25x5.40	105	28x6.40		
	25	10x3.30	35		18x4.40	48	18x4.40		50	20x4.90	80		25x5.40	110	28x6.40		
	28	10x3.30	40		18x4.40	50	18x4.40		55	20x4.90	85		25x5.40	115	28x6.40		
	30	10x3.30	42		18x4.40	55	18x4.40		60	20x4.90	90		25x5.40	120	32x7.40		
1310	11	4x1.80	2012	18	6x2.80	2525	24	8x3.30	3030	28	10x3.30	4040	42	14x3.80	5050	65	20x4.90
	12	5x2.30		19	8x3.30		25	10x3.30		30	12x3.30		45	16x4.30		70	22x5.40
	14	6x2.80		20	10x3.30		28	12x3.30		32	14x3.80		48	18x4.40		75	22x5.40
	16	8x3.30		22	12x3.30		30	14x3.80		35	16x4.30		50	20x4.90		80	25x5.40
	18	8x3.30		24	14x3.80		32	16x4.30		38	18x4.40		55	20x4.90		85	25x5.40
	19	8x3.30		25	14x3.80		35	18x4.40		40	20x4.90		60	25x5.40		90	25x5.40
	20	8x3.30		28	16x4.30		40	18x4.40		42	20x4.90		65	25x5.40		95	25x5.40
	22	8x3.30		30	18x4.40		42	18x4.40		45	20x4.90		70	25x5.40		100	28x6.40
	24	10x3.30		32	18x4.40		45	18x4.40		48	20x4.90		75	25x5.40		105	28x6.40
	25	10x3.30		35	18x4.40		48	18x4.40		50	20x4.90		80	25x5.40		110	28x6.40
	28	10x3.30		40	18x4.40		50	18x4.40		55	20x4.90		85	25x5.40		115	28x6.40
	30	10x3.30		42	18x4.40		55	18x4.40		60	20x4.90		90	25x5.40		120	32x7.40
32	10x3.30	45	18x4.40	60	18x4.40	65	20x4.90	95	25x5.40	125	32x7.40						

△-为标准宽度浅键槽

CAPT-DHT™

双螺旋人字齿同步带轮

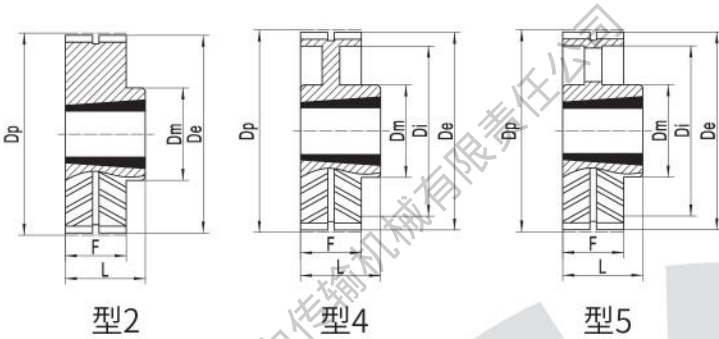

T^{aper}_B 8M16

规格	齿数	类型	锥套号	Dp	De	Di	Dm	F	L	可选用材料
TB22-8M16	22	2	1008	56.02	54.65	-	45	17	22	45 HT250 QT450 0Cr18Ni9
TB24-8M16	24	2	1108	61.12	59.75	-	50	17	22	
TB25-8M16	25	2	1108	63.66	62.29	-	50	17	22	
TB26-8M16	26	2	1108	66.21	64.84	-	50	17	22	
TB28-8M16	28	2	1108	71.30	69.93	-	50	17	22	
TB30-8M16	30	2	1108	76.40	75.03	-	50	17	22	
TB32-8M16	32	2	1610	81.49	80.12	-	71	17	25	
TB34-8M16	34	2	1610	86.58	85.21	-	71	17	25	
TB36-8M16	36	2	1610	91.68	90.30	-	71	17	25	
TB38-8M16	38	2	1610	96.77	95.40	-	71	17	25	
TB40-8M16	40	2	1610	101.86	100.49	-	71	17	25	
TB44-8M16	44	2	2012	112.05	110.68	-	92	17	32	
TB45-8M16	45	2	2012	114.59	113.22	-	92	17	32	
TB48-8M16	48	2	2012	122.23	120.86	-	96	17	32	
TB50-8M16	50	2	2012	127.33	125.96	-	96	17	32	
TB52-8M16	52	2	2012	132.42	131.05	-	96	17	32	
TB56-8M16	56	2	2012	142.61	141.24	-	110	17	32	
TB60-8M16	60	2	2012	152.79	151.42	-	110	17	32	
TB63-8M16	63	4	2012	160.43	159.06	139	110	17	32	
TB64-8M16	64	4	2012	162.98	161.61	142	110	17	32	
TB68-8M16	68	4	2012	173.17	171.79	152	110	17	32	
TB72-8M16	72	4	2012	183.35	181.98	162	110	17	32	
TB75-8M16	75	4	2012	190.99	189.62	170	110	17	32	
TB76-8M16	76	4	2012	193.54	192.17	172	110	17	32	
TB80-8M16	80	4	2012	203.72	202.35	182	110	17	32	
TB90-8M16	90	5	2012	229.19	227.82	208	110	17	32	
TB112-8M16	112	5	2517	285.21	283.84	264	125	17	45	
TB140-8M16	140	5	2517	356.52	355.15	335	125	17	45	
TB180-8M16	180	5	3020	458.38	457.01	433	170	17	51	
TB224-8M16	224	5	3020	570.43	569.06	545	170	17	51	

CAPT-DHT™

双螺旋人字齿同步带轮

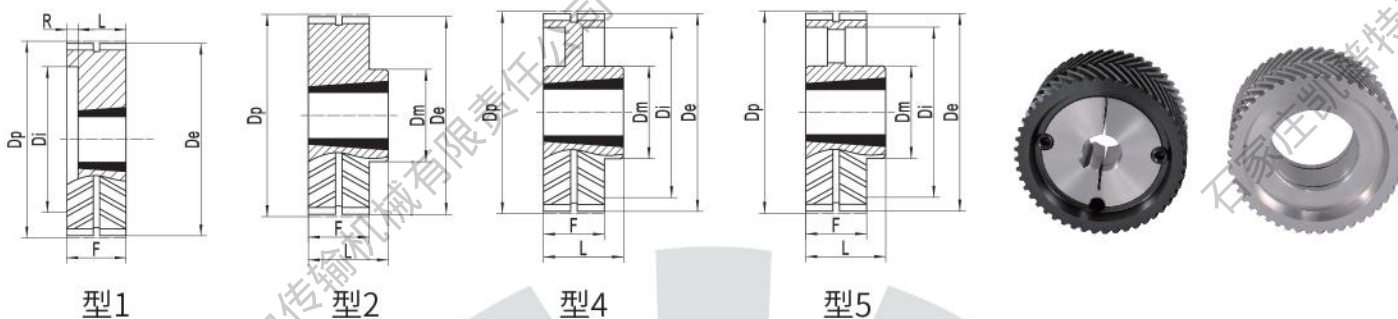

T^{aper}_B 8M32
ore

规格	齿数	类型	锥套号	Dp	De	Di	Dm	F	R	L	可选用材料	
TB22-8M32	22	1	1008	56.02	54.65	37	-	33	11	22		
TB24-8M32	24	1	1108	61.12	59.75	44	-	33	11	22		
TB25-8M32	25	1	1108	63.66	62.29	44	-	33	11	22		
TB26-8M32	26	1	1108	66.21	64.84	44	-	33	11	22		
TB28-8M32	28	1	1210	71.30	69.93	50	-	33	8	25		
TB30-8M32	30	1	1610	76.40	75.03	63	-	33	8	25		
TB32-8M32	32	2	1615	81.49	80.12	-	71	33	-	38		
TB34-8M32	34	2	1615	86.58	85.21	-	71	33	-	38		
TB36-8M32	36	2	1615	91.68	90.30	-	71	33	-	38		
TB38-8M32	38	2	1615	96.77	95.40	-	71	33	-	38		
TB40-8M32	40	2	1615	101.86	100.49	-	71	33	-	38		
TB44-8M32	44	1	2012	112.05	110.68	86	-	33	0	33	45	
TB45-8M32	45	1	2012	114.59	113.22	88	-	33	0	33	HT250	
TB48-8M32	48	1	2012	122.23	120.86	90	-	33	0	33		
TB50-8M32	50	1	2012	127.33	125.96	95	-	33	0	33		
TB52-8M32	52	1	2012	132.42	131.05	100	-	33	0	33		QT450
TB56-8M32	56	1	2012	142.61	141.24	110	-	33	0	33		
TB60-8M32	60	2	2517	152.79	151.42	-	125	33	-	45		0Cr18Ni9
TB63-8M32	63	2	2517	160.43	159.06	-	125	33	-	45		
TB64-8M32	64	2	2517	162.98	161.61	-	125	33	-	45		
TB68-8M32	68	2	2517	173.17	171.79	-	125	33	-	45		
TB72-8M32	72	4	2517	183.35	181.98	162	125	33	-	45		
TB75-8M32	75	4	2517	190.99	189.62	170	125	33	-	45		
TB76-8M32	76	4	2517	193.54	192.17	172	125	33	-	45		
TB80-8M32	80	4	2517	203.72	202.35	182	125	33	-	45		
TB90-8M32	90	4	2517	229.19	227.82	208	125	33	-	45		
TB112-8M32	112	5	2517	285.21	283.84	264	125	33	-	45		
TB140-8M32	140	5	2517	356.52	355.15	335	125	33	-	45		
TB180-8M32	180	5	3020	458.38	457.00	433	170	33	-	51	QT450	
TB224-8M32	224	5	3020	570.43	569.04	545	170	33	-	51		HT250

CAPT-DHT™

双螺旋人字齿同步带轮

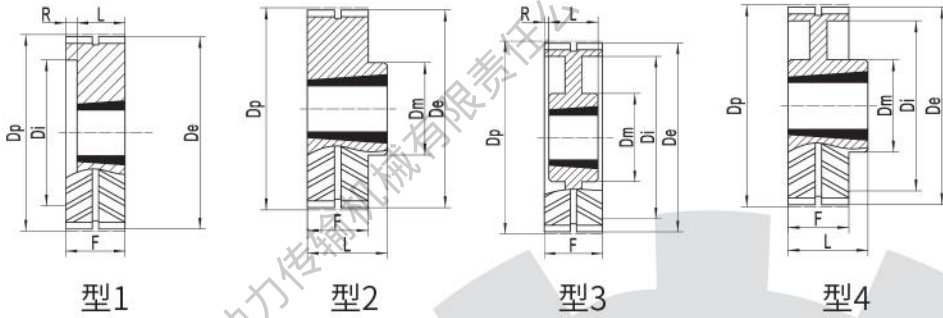

T_{aper}B_{ore} 8M64

规格	齿数	类型	锥套号	Dp	De	Di	Dm	F	R	L	可选用材料
TB28-8M64	28	1	1210	71.30	69.92	50	-	65	40	25	45 HT250 QT450 0Cr18Ni9
TB30-8M64	30	1	1615	76.39	75.01	58	-	65	27	38	
TB32-8M64	32	1	1615	81.49	80.11	63	-	65	27	38	
TB34-8M64	34	1	1615	86.58	85.20	65	-	65	27	38	
TB36-8M64	36	1	1615	91.67	90.29	68	-	65	27	38	
TB38-8M64	38	1	1615	96.77	95.39	72	-	65	27	38	
TB40-8M64	40	2	2012	101.86	100.48	80	-	65	16.5	32	
TB44-8M64	44	2	2012	112.05	110.67	86	-	65	16.5	32	
TB45-8M64	45	2	2012	114.59	113.21	86	-	65	16.5	32	
TB48-8M64	48	2	2012	122.23	120.85	86	-	65	16.5	32	
TB50-8M64	50	2	2012	127.32	125.94	86	-	65	16.5	32	
TB52-8M64	52	2	2012	132.42	131.04	86	-	65	16.5	32	
TB56-8M64	56	2	2517	142.60	141.22	116	-	65	10	45	
TB60-8M64	60	2	2517	152.79	151.41	126	-	65	10	45	
TB63-8M64	63	2	2517	160.43	159.05	130	-	65	10	45	
TB64-8M64	64	2	2517	162.98	161.60	136	-	65	10	45	
TB68-8M64	68	3	2517	173.17	171.79	152	110	65	10	45	
TB72-8M64	72	3	2517	183.35	181.97	162	125	65	10	45	
TB75-8M64	75	3	3020	190.99	189.61	170	130	65	7	51	
TB76-8M64	76	3	3020	193.53	192.15	172	130	65	7	51	
TB80-8M64	80	3	3020	203.72	202.34	182	140	65	7	51	
TB90-8M64	90	3	3020	229.18	227.80	208	160	65	7	51	
TB112-8M64	112	3	3020	285.21	283.83	264	160	65	7	51	
TB140-8M64	140	4	3020	356.51	355.14	335	160	65	7	51	
TB180-8M64	180	4	3525	458.37	457.00	433	160	65	-	65	
TB224-8M64	224	4	3525	570.41	569.04	545	160	65	-	65	

CAPT-DHT™

双螺旋人字齿同步带轮

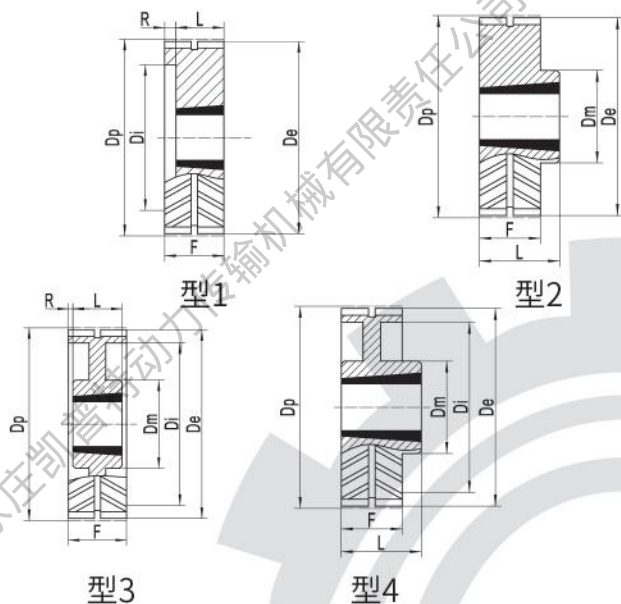

T_B^{aper}_{ore} 14M35

规格	齿数	类型	锥套号	Dp	De	Di	Dm	F	R	L	可选用材料
TB28-14M35	28	1	2012	124.78	121.99	94	-	37	5	32	45
TB30-14M35	30	1	2012	133.69	130.90	100	-	37	5	32	
TB32-14M35	32	1	2012	142.61	139.81	108	-	37	5	32	
TB34-14M35	34	2	2517	151.52	148.73	-	120	37	-	45	
TB36-14M35	36	2	2517	160.43	157.64	-	120	37	-	45	
TB38-14M35	38	2	2517	169.35	166.55	-	120	37	-	45	
TB40-14M35	40	2	2517	178.26	175.46	-	125	37	-	45	
TB43-14M35	43	2	3020	191.63	188.83	-	140	37	-	51	
TB45-14M35	45	2	3020	200.54	197.75	-	140	37	-	51	
TB48-14M35	48	2	3020	213.91	211.12	-	140	37	-	51	
TB50-14M35	50	2	3020	222.82	220.03	-	170	37	-	51	QT450
TB56-14M35	56	3	3020	249.56	246.77	208	170	37	-	51	
TB60-14M35	60	3	3020	267.39	264.59	225	170	37	-	51	0Cr18Ni9
TB63-14M35	63	3	3020	280.76	277.96	238	170	37	-	51	
TB71-14M35	71	4	3020	316.41	313.62	274	170	37	-	51	QT450 HT250
TB75-14M35	75	4	3020	334.24	331.44	292	170	37	-	51	
TB80-14M35	80	4	3020	356.52	353.72	315	170	37	-	51	
TB90-14M35	90	4	3020	401.08	398.29	360	170	37	-	51	
TB112-14M35	112	4	3020	499.12	496.33	457	170	37	-	51	
TB140-14M35	140	4	3020	623.91	621.11	581	170	37	-	51	
TB168-14M35	168	4	3020	748.69	745.89	706	170	37	-	51	

CAPT-DHT™

双螺旋人字齿同步带轮

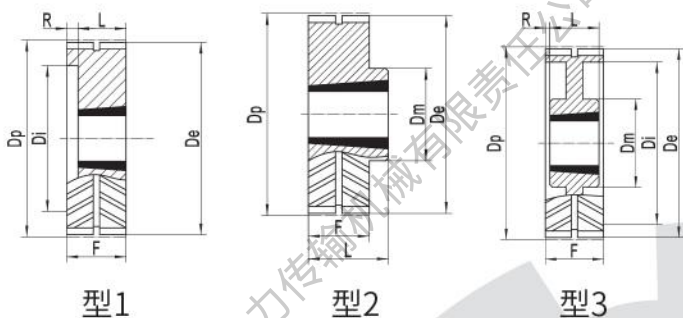

T_{aper}
B_{ore} 14M53

规格	齿数	类型	锥套号	Dp	De	Di	Dm	F	R	L	可选用材料
TB28-14M53	28	1	2012	124.78	121.99	94	-	54.5	11.25	32	45 HT250 QT450 0Cr18Ni9 QT450 HT250
TB30-14M53	30	1	2012	133.69	130.90	100	-	54.5	11.25	32	
TB32-14M53	32	1	2012	142.61	139.81	108	-	54.5	11.25	32	
TB34-14M53	34	1	2517	151.52	148.73	110	-	54.5	4.75	45	
TB36-14M53	36	1	2517	160.43	157.64	116	-	54.5	4.75	45	
TB38-14M53	38	1	2517	169.35	166.55	125	-	54.5	4.75	45	
TB40-14M53	40	1	2517	178.26	175.46	135	-	54.5	4.75	45	
TB43-14M53	43	1	3020	191.63	188.83	150	-	54.5	1.75	51	
TB45-14M53	45	1	3020	200.54	197.75	155	-	54.5	1.75	51	
TB48-14M53	48	1	3020	213.91	211.12	170	-	54.5	1.75	51	
TB50-14M53	50	1	3020	222.82	220.03	180	-	54.5	1.75	51	
TB56-14M53	56	2	3020	249.56	246.77	208	170	54.5	1.75	51	
TB60-14M53	60	2	3020	267.39	264.59	225	170	54.5	1.75	51	
TB63-14M53	63	2	3020	280.76	277.96	238	170	54.5	1.75	51	
TB71-14M53	71	2	3020	316.41	313.62	274	170	54.5	1.75	51	
TB75-14M53	75	2	3020	334.24	331.44	292	170	54.5	1.75	51	
TB80-14M53	80	3	3020	356.52	353.72	315	170	54.5	1.75	51	
TB90-14M53	90	3	3020	401.08	398.29	360	170	54.5	1.75	51	
TB112-14M53	112	3	3020	499.12	496.33	457	170	54.5	1.75	51	
TB140-14M53	140	3	3020	623.91	621.11	581	170	54.5	1.75	51	
TB168-14M53	168	3	3020	748.69	745.89	706	170	54.5	1.75	51	

CAPT-DHT™

双螺旋人字齿同步带轮

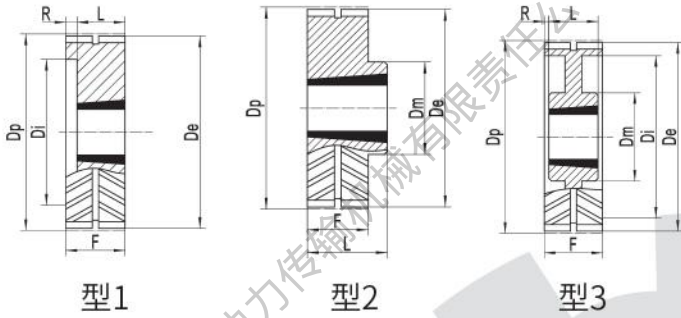

T_B^{aper} 14M70
ore

规格	齿数	类型	锥套号	Dp	De	Di	Dm	F	R	L	可选用材料
TB28-14M70	28	1	2012	124.78	121.99	94	-	72	20	32	45
TB30-14M70	30	1	2517	133.69	130.90	100	-	72	13.5	45	
TB32-14M70	32	1	2517	142.61	139.81	108	-	72	13.5	45	
TB34-14M70	34	1	2517	151.52	148.73	110	-	72	13.5	45	
TB36-14M70	36	1	2517	160.43	157.64	120	-	72	13.5	45	
TB38-14M70	38	1	2517	169.35	166.55	130	-	72	13.5	45	
TB40-14M70	40	1	2517	178.26	175.46	138	-	72	13.5	45	
TB43-14M70	43	1	3020	191.63	188.83	150	-	72	10.5	51	
TB45-14M70	45	1	3020	200.54	197.75	158	-	72	10.5	51	
TB48-14M70	48	1	3020	213.91	211.12	170	-	72	10.5	51	
TB50-14M70	50	1	3020	222.82	220.03	180	-	72	10.5	51	HT250 QT450 0Cr18Ni9
TB56-14M70	56	1	3020	249.56	246.77	208	-	72	10.5	51	
TB60-14M70	60	2	3020	267.39	264.59	225	170	72	10.5	51	
TB63-14M70	63	2	3020	280.76	277.96	238	170	72	10.5	51	
TB71-14M70	71	2	3020	316.41	313.62	274	170	72	10.5	51	
TB75-14M70	75	2	3020	334.24	331.44	292	170	72	10.5	51	
TB80-14M70	80	3	3020	356.52	353.72	314	170	72	10.5	51	
TB90-14M70	90	3	3020	401.08	398.29	358	170	72	10.5	51	
TB112-14M70	112	3	3020	499.12	496.33	455	170	72	10.5	51	
TB140-14M70	140	3	3020	623.91	621.11	580	170	72	10.5	51	
TB168-14M70	168	3	3020	748.69	745.89	706	170	72	10.5	51	QT450 HT250

CAPT-DHT™

双螺旋人字齿同步带轮

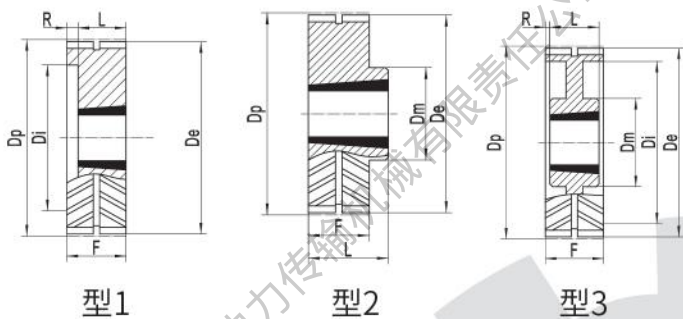

Taper B_{ore} 14M105

规格	齿数	类型	锥套号	Dp	De	Di	Dm	F	R	L	可选用材料
TB28-14M105	28	1	2517	124.78	121.99	98	-	107	31	45	45 HT250 QT450 0Cr18Ni9
TB30-14M105	30	1	2517	133.69	130.90	100	-	107	31	45	
TB32-14M105	32	1	2517	142.61	139.81	108	-	107	31	45	
TB34-14M105	34	1	2517	151.52	148.73	110	-	107	31	45	
TB36-14M105	36	1	3020	160.43	157.64	125	-	107	28	51	
TB38-14M105	38	1	3020	169.35	166.55	130	-	107	28	51	
TB40-14M105	40	1	3020	178.26	175.46	138	-	107	28	51	
TB43-14M105	43	1	3030	191.63	188.83	150	-	107	15.5	76	
TB45-14M105	45	1	3030	200.54	197.75	158	-	107	15.5	76	
TB48-14M105	48	1	3030	213.91	211.12	170	-	107	15.5	76	
TB50-14M105	50	1	3030	222.82	220.03	180	-	107	15.5	76	
TB56-14M105	56	1	3525	249.56	246.77	210	-	107	21	65	
TB60-14M105	60	2	3525	267.39	264.59	225	190	107	21	65	
TB63-14M105	63	2	3525	280.76	277.96	235	190	107	21	65	
TB71-14M105	71	2	3525	316.41	313.62	274	190	107	21	65	
TB75-14M105	75	2	3525	334.24	331.44	290	190	107	21	65	
TB80-14M105	80	3	3525	356.52	353.72	315	190	107	21	65	
TB90-14M105	90	3	3525	401.08	398.29	360	190	107	21	65	
TB112-14M105	112	3	3525	499.12	496.33	457	190	107	21	65	
TB140-14M105	140	3	3525	623.91	621.11	580	190	107	21	65	
TB168-14M105	168	3	3525	748.69	745.89	706	190	107	21	65	

CAPT-DHT™

双螺旋人字齿同步带轮

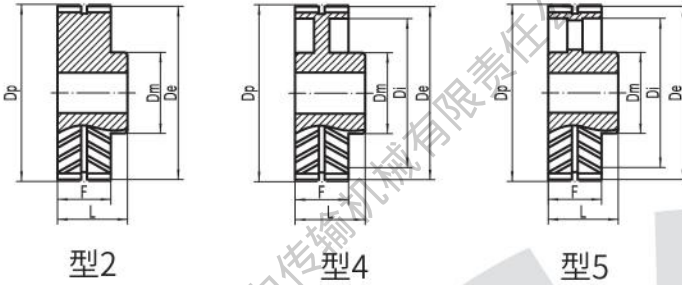

**F^{inished}
B^{ore}** 8M16

规格	齿数	类型	Dp	De	Di	Dm	F	L	d最小	d最大	可选用材料	
18-8M16	18	2	45.84	44.47	-	38	17	22	10	25	45	
20-8M16	20	2	50.93	49.56	-	41	17	22	10	25		
22-8M16	22	2	56.02	54.65	-	45	17	22	10	30		
24-8M16	24	2	61.12	59.75	-	50	17	22	10	35		
25-8M16	25	2	63.66	62.29	-	50	17	22	12	35		
26-8M16	26	2	66.21	64.84	-	50	17	22	12	35		
28-8M16	28	2	71.30	69.93	-	50	17	22	14	35		
30-8M16	30	2	76.40	75.03	-	50	17	22	14	35		
32-8M16	32	2	81.49	80.12	-	71	17	25	14	50		
34-8M16	34	2	86.58	85.21	-	71	17	25	14	50		
36-8M16	36	2	91.68	90.30	-	71	17	25	14	50		
38-8M16	38	2	96.77	95.40	-	71	17	25	14	50		
40-8M16	40	2	101.86	100.49	-	71	17	25	14	50		
44-8M16	44	2	112.05	110.68	-	92	17	32	14	65		
45-8M16	45	2	114.59	113.22	-	92	17	32	14	65		
48-8M16	48	2	122.23	120.86	-	96	17	32	20	65	HT250	
50-8M16	50	2	127.33	125.96	-	96	17	32	20	65		
52-8M16	52	2	132.42	131.05	-	96	17	32	20	65		QT450
56-8M16	56	2	142.61	141.24	-	110	17	32	20	75		
60-8M16	60	2	152.79	151.42	-	110	17	32	20	75		0Cr18Ni9
63-8M16	63	4	160.43	159.06	139	110	17	32	20	75		
64-8M16	64	4	162.98	161.61	142	110	17	32	20	75		
68-8M16	68	4	173.17	171.79	152	110	17	32	20	75		
72-8M16	72	4	183.35	181.98	162	110	17	32	20	75		
75-8M16	75	4	190.99	189.62	170	110	17	32	20	75		
76-8M16	76	4	193.54	192.17	172	110	17	32	20	75		
80-8M16	80	4	203.72	202.35	182	110	17	32	20	75		
90-8M16	90	5	229.19	227.82	208	110	17	32	20	75		
112-8M16	112	5	285.21	283.84	264	125	17	45	20	80		
140-8M16	140	5	356.52	355.15	335	125	17	45	20	80		
180-8M16	180	5	458.38	457.01	433	170	17	51	20	110	QT450 HT250	
224-8M16	224	5	570.43	569.06	545	170	17	51	20	110		

CAPT-DHT™

双螺旋人字齿同步带轮

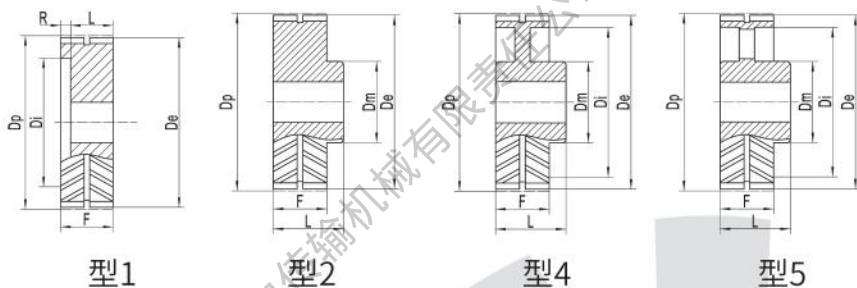

F^{inished}
B_{ore} 8M32

规格	齿数	类型	Dp	De	Di	Dm	F	R	L	d最小	d最大	可选用材料
18-8M32	18	1	45.84	44.47	-	-	33	-	33	10	25	45 HT250 QT450 0Cr18Ni9
20-8M32	20	1	50.93	49.56	-	-	33	-	33	12	25	
22-8M32	22	1	56.02	54.65	-	-	33	-	33	12	30	
24-8M32	24	1	61.12	59.75	-	-	33	-	33	12	35	
25-8M32	25	1	63.66	62.29	-	-	33	-	33	14	35	
26-8M32	26	1	66.21	64.84	-	-	33	-	33	14	35	
28-8M32	28	1	71.30	69.93	50	-	33	8	25	14	35	
30-8M32	30	1	76.40	75.03	63	-	33	8	25	14	35	
32-8M32	32	2	81.49	80.12	-	71	33	-	38	14	50	
34-8M32	34	2	86.58	85.21	-	71	33	-	38	14	50	
36-8M32	36	2	91.68	90.30	-	71	33	-	38	14	50	
38-8M32	38	2	96.77	95.40	-	71	33	-	38	14	50	
40-8M32	40	2	101.86	100.49	-	71	33	-	38	14	50	
44-8M32	44	1	112.05	110.68	86	-	33	-	33	20	65	
45-8M32	45	1	114.59	113.22	88	-	33	-	33	20	65	
48-8M32	48	1	122.23	120.86	90	-	33	-	33	20	65	
50-8M32	50	1	127.33	125.96	95	-	33	-	33	20	65	
52-8M32	52	1	132.42	131.05	100	-	33	-	33	20	65	
56-8M32	56	1	142.61	141.24	110	-	33	-	33	20	75	
60-8M32	60	2	152.79	151.42	-	125	33	-	45	20	75	
63-8M32	63	2	160.43	159.06	-	125	33	-	45	20	75	
64-8M32	64	2	162.98	161.61	-	125	33	-	45	20	75	
68-8M32	68	2	173.17	171.79	-	125	33	-	45	20	75	
72-8M32	72	4	183.35	181.98	162	125	33	-	45	20	75	
75-8M32	75	4	190.99	189.62	170	125	33	-	45	20	75	
76-8M32	76	4	193.54	192.17	172	125	33	-	45	20	75	
80-8M32	80	4	203.72	202.35	182	125	33	-	45	20	75	
90-8M32	90	4	229.19	227.82	208	125	33	-	45	20	75	
112-8M32	112	5	285.21	283.84	264	125	33	-	45	20	80	
140-8M32	140	5	356.52	355.15	335	125	33	-	45	20	80	
180-8M32	180	5	458.38	457.00	433	170	33	-	51	20	110	
224-8M32	224	5	570.43	569.04	545	170	33	-	51	20	110	

CAPT-DHT™

双螺旋人字齿同步带轮

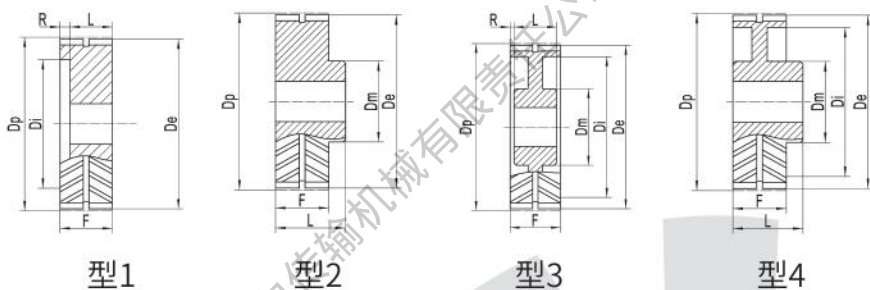

F^{inished}
B^{ore} 8M64

规格	齿数	类型	Dp	De	Di	Dm	F	R	L	d最小	d最大	可选用材料
18-8M64	18	1	45.84	44.47	-	-	65	-	65	10	25	45 HT250 QT450 0Cr18Ni9
20-8M64	20	1	50.93	49.55	-	-	65	-	65	10	25	
22-8M64	22	1	56.02	54.64	-	-	65	-	65	12	30	
24-8M64	24	1	61.12	59.74	-	-	65	-	65	12	35	
25-8M64	25	1	63.66	62.28	-	-	65	-	65	14	35	
26-8M64	26	1	66.21	64.83	-	-	65	-	65	14	35	
28-8M64	28	1	71.30	69.92	50	-	65	40	25	14	35	
30-8M64	30	1	76.39	75.01	58	-	65	27	38	14	35	
32-8M64	32	1	81.49	80.11	63	-	65	27	38	14	48	
34-8M64	34	1	86.58	85.20	65	-	65	27	38	14	50	
36-8M64	36	1	91.67	90.29	68	-	65	27	38	14	50	
38-8M64	38	1	96.77	95.39	72	-	65	27	38	14	50	
40-8M64	40	2	101.86	100.48	80	-	65	16.5	32	14	50	
44-8M64	44	2	112.05	110.67	86	-	65	16.5	32	14	65	
45-8M64	45	2	114.59	113.21	86	-	65	16.5	32	14	65	
48-8M64	48	2	122.23	120.85	86	-	65	16.5	32	14	65	
50-8M64	50	2	127.32	125.94	86	-	65	16.5	32	14	65	
52-8M64	52	2	132.42	131.04	86	-	65	16.5	32	14	65	
56-8M64	56	2	142.60	141.22	116	-	65	10	45	18	75	
60-8M64	60	2	152.79	151.41	126	-	65	10	45	18	80	
63-8M64	63	2	160.43	159.05	130	-	65	10	45	18	85	
64-8M64	64	2	162.98	161.60	136	-	65	10	45	18	90	
68-8M64	68	3	173.17	171.79	152	110	65	10	45	18	75	
72-8M64	72	3	183.35	181.97	162	125	65	10	45	18	80	
75-8M64	75	3	190.99	189.61	170	130	65	7	51	18	85	
76-8M64	76	3	193.53	192.15	172	130	65	7	51	18	85	
80-8M64	80	3	203.72	202.34	182	140	65	7	51	18	90	
90-8M64	90	3	229.18	227.80	208	160	65	7	51	18	105	
112-8M64	112	3	285.21	283.83	264	160	65	7	51	18	105	
140-8M64	140	4	356.51	355.14	335	160	65	7	51	18	105	
180-8M64	180	4	458.37	457.00	433	160	65	-	65	20	105	QT450
224-8M64	224	4	570.41	569.04	545	160	65	-	65	20	105	HT250

CAPT-DHT™

双螺旋人字齿同步带轮

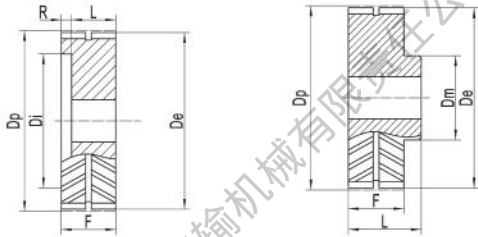

型1

型2

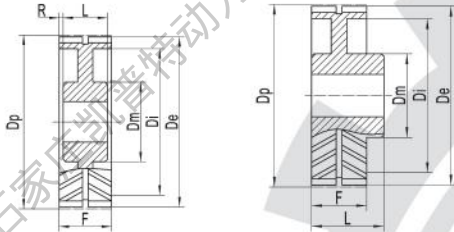

型3

型4



F^{inished}
B_{ore} 14M35

规格	齿数	类型	Dp	De	Di	Dm	F	R	L	d最小	d最大	可选用材料
28-14M35	28	1	124.78	121.99	94	-	37	5	32	24	70	45 HT250 QT450 0Cr18Ni9
30-14M35	30	1	133.69	130.90	100	-	37	5	32	24	75	
32-14M35	32	1	142.61	139.81	108	-	37	5	32	24	80	
34-14M35	34	2	151.52	148.73	-	120	37	-	45	24	80	
36-14M35	36	2	160.43	157.64	-	120	37	-	45	24	80	
38-14M35	38	2	169.35	166.55	-	120	37	-	45	24	80	
40-14M35	40	2	178.26	175.46	-	125	37	-	45	24	80	
43-14M35	43	2	191.63	188.83	-	140	37	-	51	24	90	
45-14M35	45	2	200.54	197.75	-	140	37	-	51	24	90	
48-14M35	48	2	213.91	211.12	-	140	37	-	51	24	90	
50-14M35	50	2	222.82	220.03	-	170	37	-	51	24	110	
56-14M35	56	3	249.56	246.77	208	170	37	-	51	28	110	
60-14M35	60	3	267.39	264.59	225	170	37	-	51	28	110	
63-14M35	63	3	280.76	277.96	238	170	37	-	51	28	110	
71-14M35	71	4	316.41	313.62	274	170	37	-	51	28	110	
75-14M35	75	4	334.24	331.44	292	170	37	-	51	28	110	
80-14M35	80	4	356.52	353.72	315	170	37	-	51	28	110	
90-14M35	90	4	401.08	398.29	360	170	37	-	51	28	110	
112-14M35	112	4	499.12	496.33	457	170	37	-	51	28	110	
140-14M35	140	4	623.91	621.11	581	170	37	-	51	28	110	QT450 HT250
168-14M35	168	4	748.69	745.89	706	170	37	-	51	28	110	

CAPT-DHT™

双螺旋人字齿同步带轮

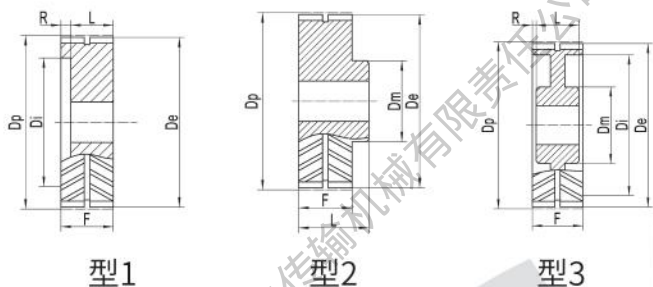

F_B^{insished} **14M53**
ore

规格	齿数	类型	Dp	De	Di	Dm	F	R	L	d最小	d最大	可选用材料
28-14M53	28	1	124.78	121.99	94	-	54.5	11.25	32	24	70	45 HT250 QT450 0Cr18Ni9
30-14M53	30	1	133.69	130.90	100	-	54.5	11.25	32	24	75	
32-14M53	32	1	142.61	139.81	108	-	54.5	11.25	32	24	80	
34-14M53	34	1	151.52	148.73	110	-	54.5	4.75	45	24	80	
36-14M53	36	1	160.43	157.64	116	-	54.5	4.75	45	24	80	
38-14M53	38	1	169.35	166.55	125	-	54.5	4.75	45	24	80	
40-14M53	40	1	178.26	175.46	135	-	54.5	4.75	45	24	90	
43-14M53	43	1	191.63	188.83	150	-	54.5	1.75	51	24	100	
45-14M53	45	1	200.54	197.75	155	-	54.5	1.75	51	24	100	
48-14M53	48	1	213.91	211.12	170	-	54.5	1.75	51	24	110	
50-14M53	50	1	222.82	220.03	180	-	54.5	1.75	51	24	120	
56-14M53	56	2	249.56	246.77	208	170	54.5	1.75	51	28	110	
60-14M53	60	2	267.39	264.59	225	170	54.5	1.75	51	28	110	
63-14M53	63	2	280.76	277.96	238	170	54.5	1.75	51	28	110	
71-14M53	71	2	316.41	313.62	274	170	54.5	1.75	51	28	110	
75-14M53	75	2	334.24	331.44	292	170	54.5	1.75	51	28	110	
80-14M53	80	3	356.52	353.72	315	170	54.5	1.75	51	28	110	
90-14M53	90	3	401.08	398.29	360	170	54.5	1.75	51	28	110	
112-14M53	112	3	499.12	496.33	457	170	54.5	1.75	51	28	110	
140-14M53	140	3	623.91	621.11	581	170	54.5	1.75	51	28	110	
168-14M53	168	3	748.69	745.89	706	170	54.5	1.75	51	28	110	

CAPT-DHT™

双螺旋人字齿同步带轮

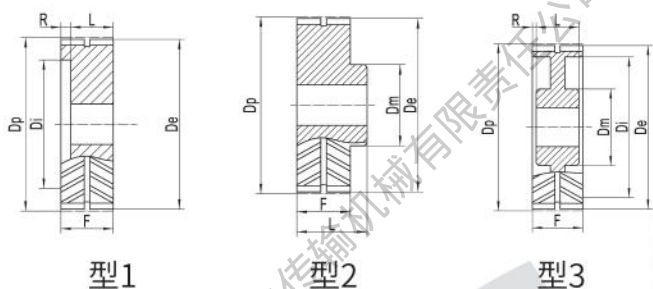

F_{insished}
B_{ore} 14M70

规格	齿数	类型	Dp	De	Di	Dm	F	R	L	d最小	d最大	可选用材料
28-14M70	28	1	124.78	121.99	94	-	72	20	32	24	70	45 HT250
30-14M70	30	1	133.69	130.90	100	-	72	13.5	45	24	75	
32-14M70	32	1	142.61	139.81	108	-	72	13.5	45	24	80	
34-14M70	34	1	151.52	148.73	110	-	72	13.5	45	24	80	
36-14M70	36	1	160.43	157.64	120	-	72	13.5	45	24	80	
38-14M70	38	1	169.35	166.55	130	-	72	13.5	45	24	85	
40-14M70	40	1	178.26	175.46	138	-	72	13.5	45	24	90	
43-14M70	43	1	191.63	188.83	150	-	72	10.5	51	24	100	
45-14M70	45	1	200.54	197.75	158	-	72	10.5	51	24	105	
48-14M70	48	1	213.91	211.12	170	-	72	10.5	51	24	110	
50-14M70	50	1	222.82	220.03	180	-	72	10.5	51	28	120	0Cr18Ni9 QT450 HT250
56-14M70	56	1	249.56	246.77	208	-	72	10.5	51	28	135	
60-14M70	60	2	267.39	264.59	225	170	72	10.5	51	28	110	
63-14M70	63	2	280.76	277.96	238	170	72	10.5	51	28	110	
71-14M70	71	2	316.41	313.62	274	170	72	10.5	51	28	110	
75-14M70	75	2	334.24	331.44	292	170	72	10.5	51	28	110	
80-14M70	80	3	356.52	353.72	314	170	72	10.5	51	28	110	
90-14M70	90	3	401.08	398.29	358	170	72	10.5	51	28	110	
112-14M70	112	3	499.12	496.33	455	170	72	10.5	51	28	110	
140-14M70	140	3	623.91	621.11	580	170	72	10.5	51	28	110	
168-14M70	168	3	748.69	745.89	706	170	72	10.5	51	28	110	

CAPT-DHT™

双螺旋人字齿同步带轮

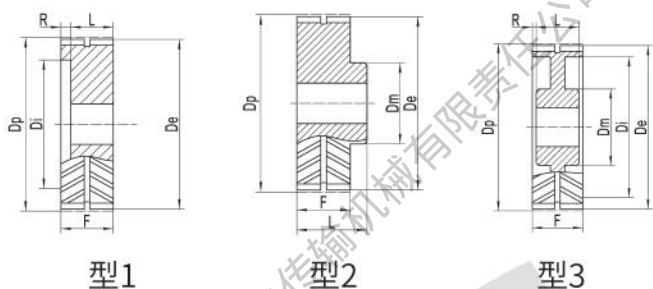

F^{insished}_B 14M105
ore

规格	齿数	类型	Dp	De	Di	Dm	F	R	L	d最小	d最大	可选用材料
28-14M105	28	1	124.78	121.99	98	-	107	31	45	24	70	45 HT250 QT450 0Cr18Ni9
30-14M105	30	1	133.69	130.90	100	-	107	31	45	24	75	
32-14M105	32	1	142.61	139.81	108	-	107	31	45	24	80	
34-14M105	34	1	151.52	148.73	110	-	107	31	45	24	80	
36-14M105	36	1	160.43	157.64	125	-	107	28	51	32	80	
38-14M105	38	1	169.35	166.55	130	-	107	28	51	32	85	
40-14M105	40	1	178.26	175.46	138	-	107	28	51	32	90	
43-14M105	43	1	191.63	188.83	150	-	107	15.5	76	32	100	
45-14M105	45	1	200.54	197.75	158	-	107	15.5	76	32	105	
48-14M105	48	1	213.91	211.12	170	-	107	15.5	76	32	110	
50-14M105	50	1	222.82	220.03	180	-	107	15.5	76	32	120	
56-14M105	56	1	249.56	246.77	210	-	107	21	65	32	140	
60-14M105	60	2	267.39	264.59	225	190	107	21	65	32	125	
63-14M105	63	2	280.76	277.96	235	190	107	21	65	32	125	
71-14M105	71	2	316.41	313.62	274	190	107	21	65	32	125	
75-14M105	75	2	334.24	331.44	290	190	107	21	65	32	125	
80-14M105	80	3	356.52	353.72	315	190	107	21	65	32	125	
90-14M105	90	3	401.08	398.29	360	190	107	21	65	32	125	
112-14M105	112	3	499.12	496.33	457	190	107	21	65	32	125	
140-14M105	140	3	623.91	621.11	580	190	107	21	65	32	125	
168-14M105	168	3	748.69	745.89	706	190	107	21	65	32	125	QT450 HT250

应用领域



饲料机械



食品机械



纺织机械



矿山机械



农业机械



包装机械



消防设备



物流机械



医疗设备



石油机械



印刷机械



木材加工